

Article number: 12712000040500

Description: KLEE-coil 712 000 040.500
M4 St. steel 1.4305

Measures

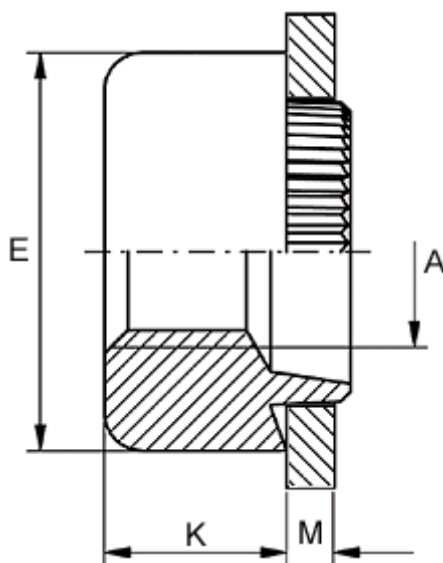

Female thread A	= M4
Height K	= 4.0
Outer diameter E	= 10.0
Plate thickness	= 3.2 to 3.4
Recommended bore diameter for extreme load	= 7.0
Recommended bore diameter for normal use	= 7.0